

Application

Uniform interface for configuration and operation of various smart SAMSON devices

TROVIS-VIEW provides a uniform user interface that allows users to configure and parameterize various SAMSON devices using device-specific database modules. All smart SAMSON devices are listed in Table 2.

Data are transmitted between the TROVIS-VIEW software and the SAMSON device either directly (e.g. using a connecting cable or infrared adapter. Refer also to Table 2) or indirectly using a memory pen or memory module.

A direct connection enables both online and offline operation. This means that data can be changed in the device immediately, or they can be saved on the PC first and downloaded later to the device on site.

The device-specific modules contain a database that provides the characteristic properties of each device type, such as parameters, data points, user levels etc.

The various user levels can be password-protected.

The available modules are constantly adapted to the new firmware versions of devices. New modules are also being constantly added.

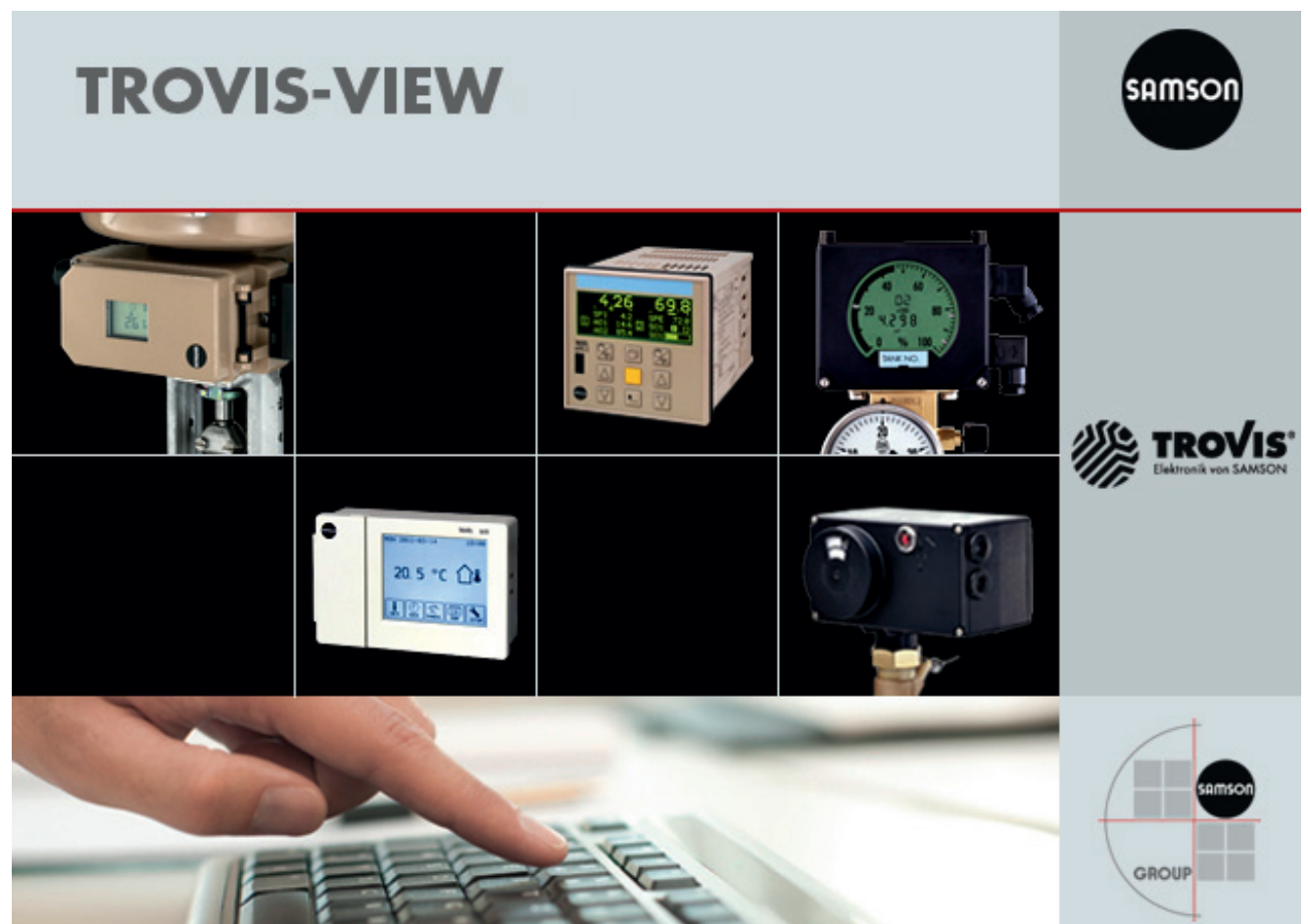

The image displays the TROVIS-VIEW software interface and various SAMSON hardware components. The top left features the text "TROVIS-VIEW" in a large, bold, sans-serif font. To the right of this text is the SAMSON logo, a black circle with the word "SAMSON" in white. Below the text and logo is a grid of six images showing different SAMSON devices: a beige valve actuator, a beige electronic controller with a green LCD display showing "4.26" and "69.8", a black square valve actuator with a green dial, a white electronic controller with a blue LCD display showing "20.5 °C", and a black valve actuator. To the right of the grid is the TROVIS logo, a stylized black and white graphic with the text "TROVIS" and "Elektronik von SAMSON" below it. At the bottom right is the SAMSON GROUP logo, a black circle with the word "SAMSON" in white, and the word "GROUP" below it. At the bottom of the image is a close-up photograph of a hand pointing at a laptop keyboard.

Learning to operate TROVIS-VIEW is easy, as it uses the look and feel of Windows® Explorer. It includes features such as:

- Tree structure
- List view
- Select
- Context-sensitive menus by clicking the right mouse button
- Open and save

Versions

A new software version was launched in mid 2011. This new version, TROVIS-VIEW 4, includes all the features of TROVIS-VIEW 3 as well as incorporating new features, such as a find command to search for parameters and folders, creation of a user-defined tree and new Trend-Viewer functions. Not all device modules are currently available for TROVIS-VIEW 4. Device modules already available for TROVIS-VIEW 4 are marked in Table 2.

System requirements for TROVIS-VIEW 4

Hardware requirements (minimum):

- PC with Pentium processor or equivalent (1 GHz or faster), at least 512 MB RAM
- Serial RS-232 interface or USB interface (with USB to RS-232 adapter or USB Converter 3 for TROVIS 5500 Automation System) and suitable hardware depending on the SAMSON device used
- 1 GB hard drive space for x86 and 2 GB hard drive space for x64 of free disk space (includes installation of Microsoft® .NET Framework 4.0)

Software requirements:

- Operating system: Windows® XP, Windows® Vista, Windows® 7 (administrator rights required to install the software)
- Microsoft® .NET Framework 4.0 or higher
- Web browser: Microsoft® Internet Explorer® (version 6.0 or higher)
- PDF reader

System requirements for TROVIS-VIEW 3

Hardware requirements (minimum):

- PC with Pentium processor or equivalent (300 MHz or faster, 500 MHz recommended)
- Serial interface and suitable hardware depending on SAMSON device used
- At least 96 MB RAM, 192 MB RAM or more recommended
- At least 150 MB available hard drive space additionally, 15 to 30 MB available hard drive space per SAMSON module

Software requirements:

- Operating system: Windows® 2000 (SP2 or higher), Windows® XP, Windows® Vista, Windows® 7 (administrator rights required to install the software)
- Microsoft® .NET Framework Version 2.0 or higher (included on installation CD-ROM). If not already installed:
 - Under Windows® 2000 and XP (without SP2), Microsoft® .NET Framework 2.0 is installed
 - Under Windows® XP with SP2, Microsoft® .NET Framework 3.5 is installed
- PDF reader

Scope of delivery

The TROVIS-VIEW 3 and TROVIS-VIEW 4 software versions can be downloaded free of charge from our website (► www.samson.de at Services > Software > TROVIS-VIEW). The software can also be supplied on a CD-ROM on request.

- CD-ROM with TROVIS-VIEW 3.60 Type 6661
Var.-ID 2938757
- CD-ROM with TROVIS-VIEW 4 Type 6661
Var.-ID 2938759

Table 1: Accessories (Fig. 1 to Fig. 3)

Accessories	Order no.
USB/RS-232 adapter	8812-2001
USB converter 3	1400-9377
Hardware package consisting of memory pen-64, modular adapter and connecting cable	1400-9998
Memory pen-64 (1170-3163)	1400-9753
Modular adapter	1400-7698
Memory module for TROVIS 5500 Automation System	1400-9379
Connecting cable RJ-12/D-Sub, 9 pin	1400-7699
Infrared adapter RS-232	8864-0900
Fixture for infrared adapter for TROVIS 6493 and TROVIS 6495-2	1400-9769
USB cable (mini-B, USB type A)	8801-7301
Serial interface adapter	1400-7700
Isolated USB interface adapter	1400-9740
FSK modem for HART® communication (TROVIS-VIEW can only use HART® communication with Type 3780 Positioner, not with Types 3730-3, 3730-6 and 3731-3)	
– RS-232 EEx (ia)	8812-0129
– RS-232 (no explosion protection)	8812-0130
– PCMCIA (no explosion protection)	8812-0131
– USB (no explosion protection)	8812-0132

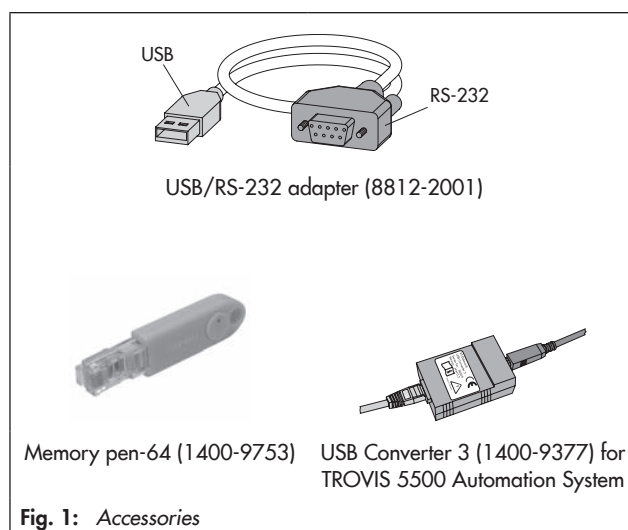

Fig. 1: Accessories

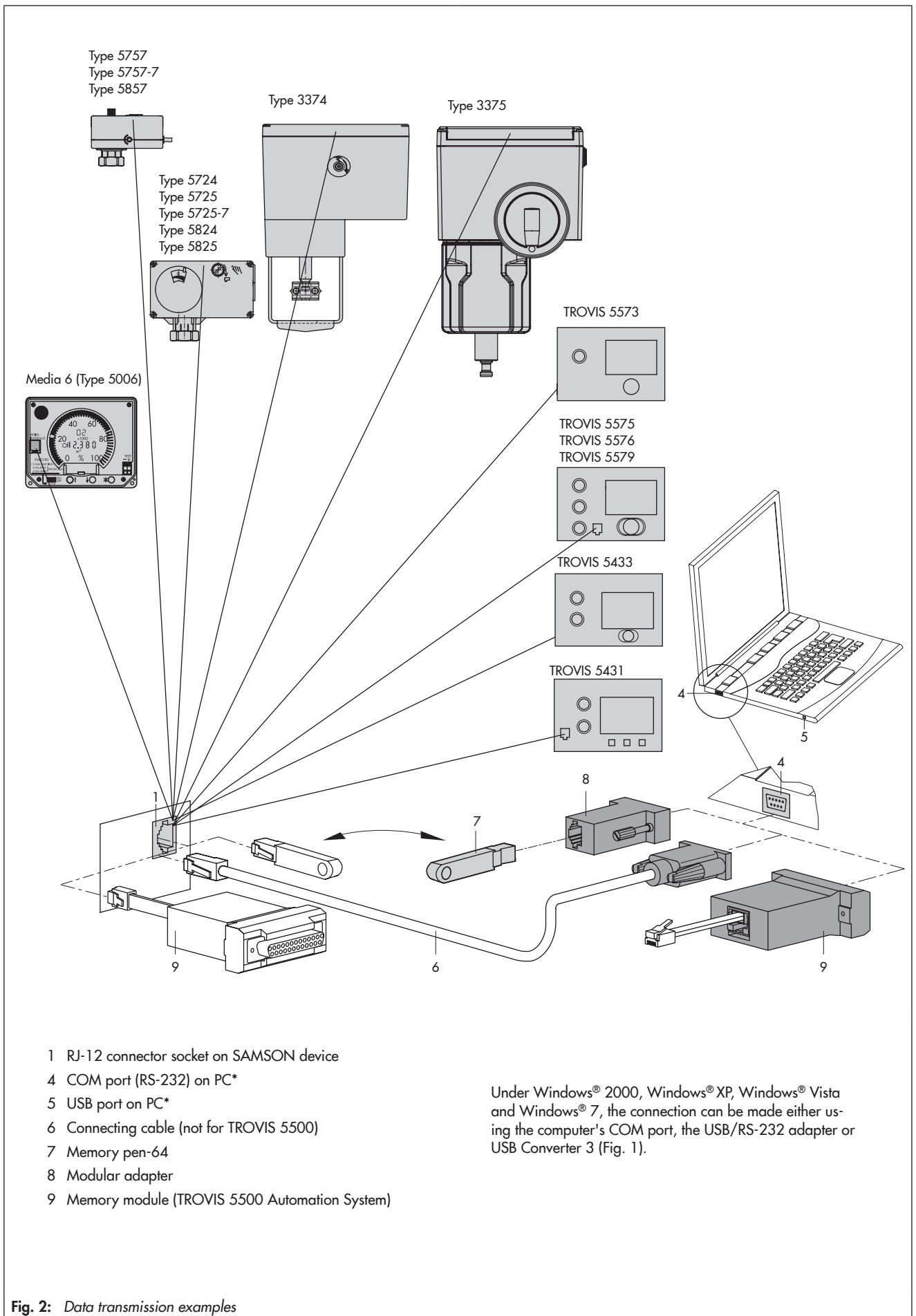

Fig. 2: Data transmission examples

- 1 RJ-12 connector socket on SAMSON device
- 2 Infrared interface on SAMSON device
- 3 USB interface on SAMSON device
- 4 COM port (RS-232) on PC*
- 5 USB port on PC*
- 6 Connecting cable
- 7 Memory pen-64
- 8 Modular adapter
- 10 Serial interface adapter
- 11 FSK modem

- 12 Infrared adapter (RS-232)
- 13 USB cable (5-pin mini-B/USB type A)
- 14 Isolated USB interface adapter

* Under Windows® 2000, Windows® XP, Windows® Vista and Windows® 7, the connection can be made either using the computer's COM port, the USB/RS-232 adapter or USB Converter 3 (Fig. 1).

Types 3730-2/-3/-4/-5/-6,
Types 3731-3/-5,
Type 3785, Type 3787,
Type 3738-20

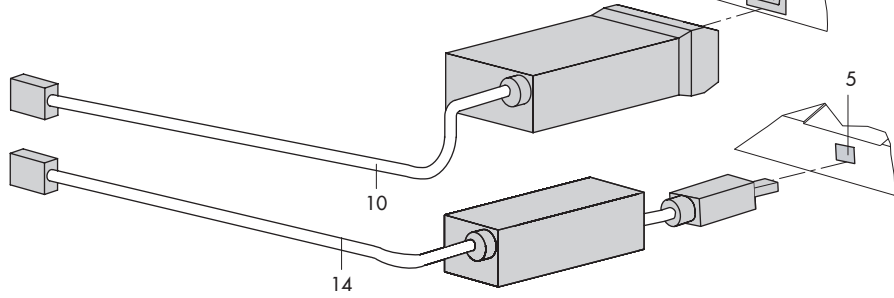
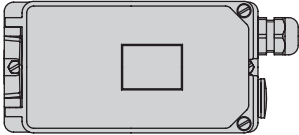

Type 3780

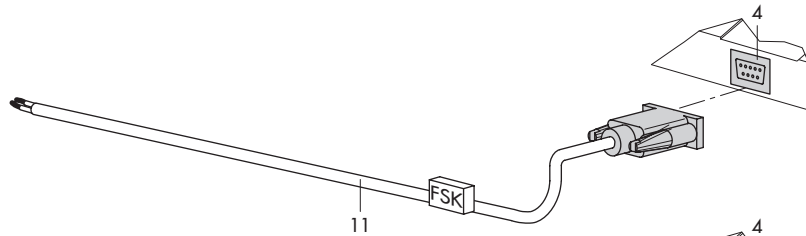
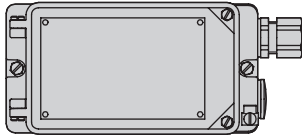

TROVIS 5432

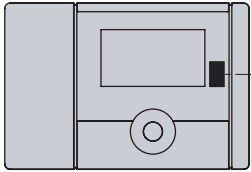

TROVIS 6493

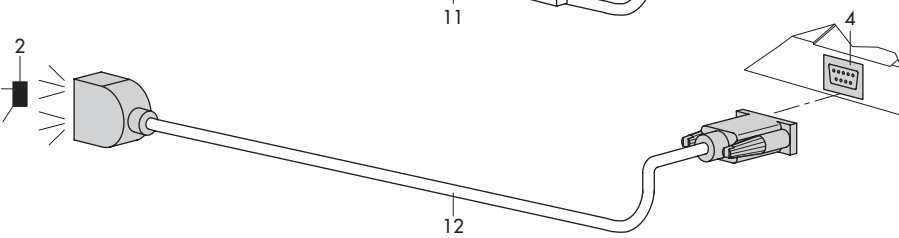

TROVIS 6495-2

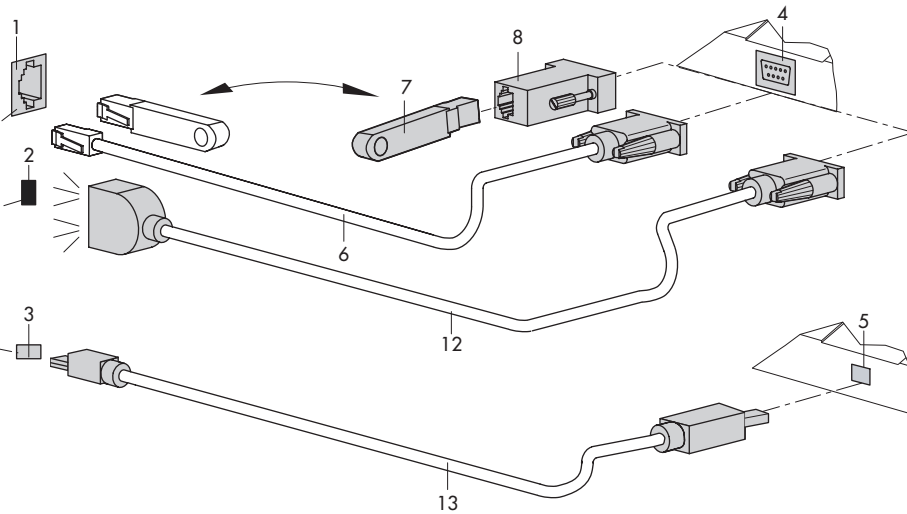
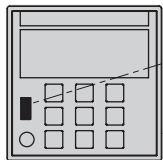

Fig. 3: Data transmission examples

Table 2: Data transmission

SAMSON devices	TROVIS-VIEW 4	TROVIS-VIEW 3	Data transmission																		
			Direct						Indirect												
			Connecting cable (1400-7699)	FSK modem (8812-01xx)	Serial interface adapter (1400-7700)	Isolated USB interface adapter (1400-9740)	Infrared adapter RS-232 (8864-0900)	USB Converter 3 (1400-9377)	USB cable (8801-7301)	Memory pen (until April 2010)	Memory pen-64 (1400-9753)	Memory module (1400-9379)	Modular adapter (1400-7698)								
Heating controllers																					
TROVIS 5431	-	V 1.00 to 1.29	•										•	•							•
TROVIS 5432	-	V 1.01 to 2.19						•													
TROVIS 5433	-	V 1.00 to 1.29	•										•	•							•
TROVIS 5573	-	V 1.80 to 1.99 patch up to 2.09							•											•	
TROVIS 5575	-	V 1.20 to 1.99 patch up to 2.09							• ¹⁾											•	
TROVIS 5576	-	V 1.00 to 1.99 patch up to 2.09							• ¹⁾											•	
TROVIS 5579	-	V 1.20 to 1.99 patch up to 2.09							• ¹⁾											•	
TROVIS 5610	-	-																			
Compact controllers																					
TROVIS 6493	V 2.03, 3.03 and V 4.00 and higher	V 2.03 and 3.03						•													
TROVIS 6495-2 Industrial Controller																					
Without interface board								•													
With RS-232/USB interface board	V 1.00 and higher	V 1.00 to 1.11	•					•		•			•						•		•
With RS-485/USB interface board								•		•											
Electropneumatic positioners																					
Type 3730-2	V 1.10 and higher	V 1.10 to 1.54			•	•															
Type 3730-3 (HART®)	V 1.10 and higher	V 1.10 to 1.54		• ²⁾	•	•															
Type 3730-4 (PROFIBUS-PA)	R 1.43/K 1.00 and higher	R 1.43/K 1.00 to R 1.46/K 1.16			•	•															
Type 3730-5 (FOUNDATION™ fieldbus)	R 1.40/K 1.20 and higher	R 1.40/K 1.20 to R 1.52/K 2.09			•	•															
Type 3730-6 (HART®)	V 1.00 and higher	-		• ²⁾	•	•															
Electropneumatic Ex d positioners																					
Type 3731-3 (HART®)	V 1.30 and higher	V 1.30 to 1.53		• ²⁾	•	•															
Type 3731-5 (FOUNDATION™ fieldbus)	R 1.45/K 1.25	R 1.45/K 1.25			•	•															

¹⁾ Version V 1.41 and higher for TROVIS 5575, 5576, 5579

²⁾ No HART® communication between Types 3730-3, 3730-6 and 3731-3 Positioners and TROVIS-VIEW

SAMSON devices	TROVIS-VIEW 4	TROVIS-VIEW 3	Data transmission																		
			Direct						Indirect												
			Connecting cable (1400-7699)	FSK modem (8812-01xx)	Serial interface adapter (1400-7700)	Isolated USB interface adapter (1400-9740)	Infrared adapter RS-232 (8864-0900)	USB Converter 3 (1400-9377)	USB cable (8801-7301)	Memory pen (until April 2010)	Memory pen-64 (1400-9753)	Memory module (1400-9379)	Modular adapter (1400-7698)								
Positioners																					
Type 3780 (HART®)	-	K 2.11 and higher		•																	
Type 3785 (PROFIBUS®-PA) PA device profile 2.0	-	K 1.60 to 1.99			•	•															
Type 3785 (PROFIBUS®-PA) PA device profile 3.0	-	K 2.00 and higher			•	•															
Type 3787 (FOUNDATION™ fieldbus)	-	K1.10 and higher			•	•															
Electronic limit switch																					
Type 3738-20	V 1.00 and higher	V 1.00 to 1.01			•	•															
Electric actuators with positioners																					
Type 3374, rev. 1 (without display)	-	V 1.00 to 1.39	•										•	•							•
Type 3374, rev. 2 (with display)	-	-	•										•	•							•
Type 3375	-	-	•										•	•							•
Type 5824/5825	-	V 1.00 to 1.09	•										•	•							•
Type 5857	-	V 1.00 to 1.09	•										•	•							•
Controllers with electric actuators																					
Type 5757, Type 5724/5725	-	V 1.00 to 2.19	•										•	•							•
Type 5757-7, Type 5725-7	-	V 1.00 to 2.09	•										•	•							•
Digital transmitters																					
Media 6 (Type 5006)	V 2.00 and higher	V 2.00 to 3.09	•										•	•							•

Specifications subject to change without notice



SAMSON AG · MESS- UND REGELTECHNIK
Weismüllerstraße 3 · 60314 Frankfurt am Main · Germany
Phone: +49 69 4009-0 · Fax: +49 69 4009-1507
Internet: <http://www.samson.de>

T 6661 EN

2013-01-23